

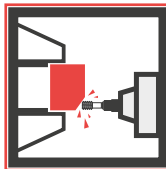

New

Zero Point Doppio

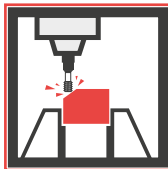

Risparmi fino al

25%

L'evoluzione continua...

Uno Zero Point versatile
posizionabile a diversi interessi
(su piastra a reticolo o dedicata)

ART.665T PNEUMATICO DOPPIO

Ripetibilità entro 0,005 mm

Standard 10kN

Opzione 18kN
mediante molle
maggiorate



Dot. Standard:
1 tirante Art.10A / 11A
2 tappi teflon
con O-Ring Art.9
1 tirante Art.11A

Tipo 1

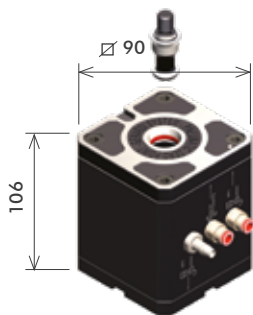

Tipo 2

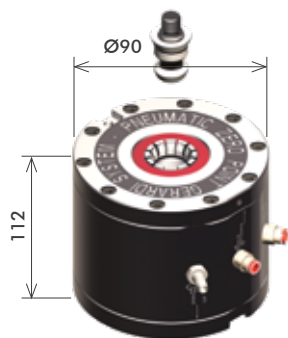

Tipo 3

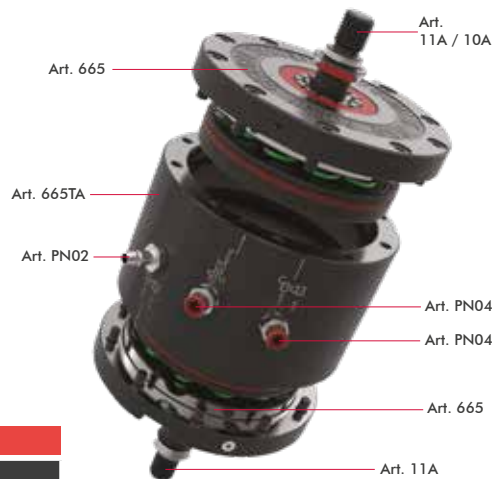
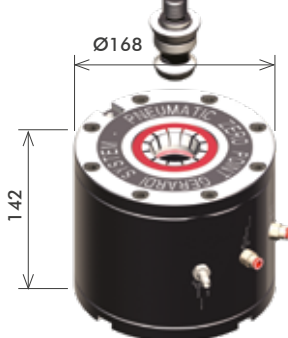

ACCIAIO	
Tipo	1
Cod.	9.66.5T100
kg	5,2
PREZZO L. €	1.300

ACCIAIO	
Tipo	2
Cod.	9.66.5T200
kg	9,7
PREZZO L. €	1.700

ACCIAIO	
Tipo	3
Cod.	9.66.5T300
kg	18,8
PREZZO L. €	2.000

€ 1.299

Forza di serraggio 5 ÷ 40 kN / Forza di arresto oltre a 60 kN / Sbloccaggio ad aria 6 ÷ 14 bar / Cono di posizionamento con compensazione assiale / Tirante a doppio centraggio per massima rigidità / Pulizia ad aria

ESTREMA VERSATILITÀ + IMMEDIATA RICONFIGURAZIONE



Lo zero point DOPPIO nasce dall'esigenza di dover serrare particolari ed attrezzature delle più svariate forme e dimensioni sulla stessa piastra base.

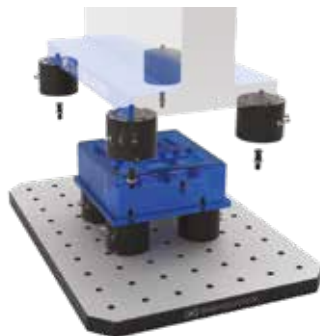

Permette di cambiare la posizione delle unità zero point per ancorare e posizionare attrezzature e particolari anche di diverse dimensioni sulla stessa piastra base.



Le unità Zero Point DOPPIE possono infatti essere posizionate a diversi interessi tramite piastre a reticolo o dedicate.





New

MillTecZero

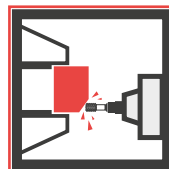
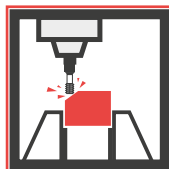

Risparmi fino al

21%

Lo Zero Point magnetico !!!
Un pallet magnetico modulare
prelavorato per lo Zero Point
(Precisione 0,005mm)

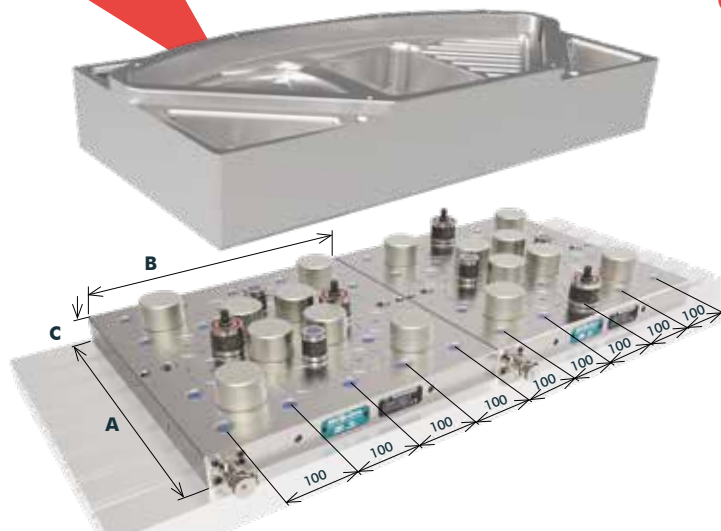

IDEALE PER CENTRI VERTICALI e ORIZZONTALI

Da Cosa è composto?

(3 attrezzature in 1)



Piano magnetico monolitico permanente MillTe con espansioni polari mobili tonde RMP

Sovratavola a reticolo modulare

Espansioni polari mobili tonde RMP 70/45

Unità di posizionamento Zero Point Art.87A

Torretta d'appoggio Art.87B

Unità Zero Point multiposizione e torrette di appoggio riposizionabili

Per Ghisa / Acciaio (Fe370 o C40)		Per Acciaio legato (38NiCrMo5 o 16MnCr5)		Dimensioni			Poli	Forza Polo	Peso	RMP	Art.87A	Art.87B	Prezzo Listino €	Prezzo Speciale €
Codice	*Forza (Ton)	Codice	*Forza (Ton)	A	B	C	(n°)	Kgf	(Kg)	(n°)	(n°)	(n°)		
Art. 88ZP		Art. 88ZPN												
1088ZP4040.K01	5,8	1088ZP4040.K01N	2,9	400	400		9		95	6			4.990	4.000
1088ZP5050.K01	10,4	1088ZP5050.K01N	5,2	500	500	51	16	652	125	8	2	2	5.990	5.000
1088ZP6363.K01	13,7	1088ZP6363.K01N	6,85	600	600		21		160	12			6.990	6.000

Dotazione standard:

▪ Piano magnetico elettro-permanente - configurazione MTB in tecnologia monolitica e superficie interamente metallica, completo di connettore rapido a tenuta stagna serie ERGON 5 ▪ Reticolo con bussole di precisione in acciaio temprato ▪ N.2 Art.87A: Unità di posizionamento Zero Point ▪ N.2 Art.87B: Torrette di appoggio complete ▪ Set di espansioni polari mobili tonde RMP 70/45 a doppio effetto ▪ Unità di controllo XT200 ▪ Estrattore tappo Zero Point magnetico Art.88ZPB

Unità di controllo Art.XT200F

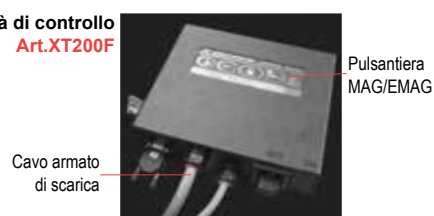

Pulsantiera MAG/EMAG

Cavo armato di scarica



Preciso, Rapido e Sicuro

Il reticolo di precisione è realizzato nella zona neutra del piano magnetico.



Riduzione dei costi

Integrando 3 diverse tecnologie (magnetismo, reticolo e Zero Point) Millteczero aumenta la produttività, migliora l'efficienza, riduce i costi e consente un rapido ritorno dell'investimento.



Espansioni Polari Mobili tonde (Art.RMP) a doppio effetto brevettate

Facili da posizionare, consentono di realizzare un letto magnetico flessibile adattandosi automaticamente alla superficie da ancorare.



Unità di posizionamento (Art.87A)

Le unità di posizionamento ZERO POINT sono predisposte per l'accoppiamento con i perni conici di precisione installati sul particolare da ancorare



StandardFLEX

Geniale sistema a pettine per la rapida sostituzione delle piastre ganasce discendenti

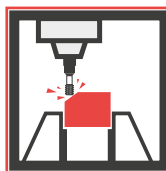

Risparmi fino al

23%

IDEALE PER CENTRI VERTICALI

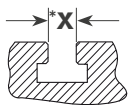

Morsa modulare di precisione serie StandardFLEX +

In omaggio:



n. 4 staffe Art. 298 + n.4 dadi a "T" Art.287

* Da comunicare in fase d'ordine



Tipo	2 - 25kN			3 - 30kN			4 - 30kN			5 - 40kN		
Apertura massima A	150	200	300	200	300	400	200	300	400	200	300	400
Larghezza ganasce W	121 mm	146 mm			171 mm			196 mm				
Altezza ganasce B	38	48			58			63				
Lunghezza base D	345	420	520	455	555	655	495	595	695			
Cod.	1.1A.20000	1.1A.32000	1.1A.33000	1.1A.42000	1.1A.43000	1.1A.44000	1.1A.52000	1.1A.53000	1.1A.54000			
PREZZO LISTINO €	798	959	1.106	1.220	1.342	1.464	1.594	1.908	2.229			
PREZZO OFFERTA €	715	769	869	1.050	1.120	1.230	1.430	1.690	1.890			

Art.1A

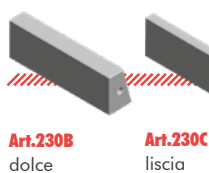
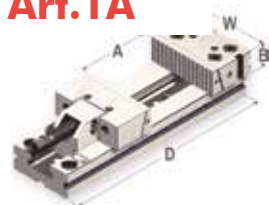

Art.230B dolce

Art.230C liscia

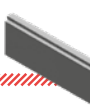

Art.230E a Gradino

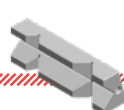

Art.230F prismatica



Art.138 a squadra sovrapponibile



Art.150 prismatica sovrapponibile

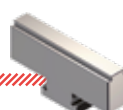

Art.212 mobile intermedia con doppio gradino



Art.257 gruppo di serraggio a vite idraulica

*Risparmi fino al

20%

* Solo se acquistate con la morsa



XL

Morse con la base molto più lunga delle normali morse standardi

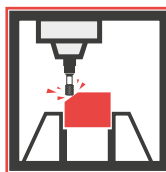

*Risparmi fino al

27%

Morsa serie XL con dotazione standard +

In omaggio:



n. 6 staffe Art. 298 + n.6 dadi a "T" Art.287



Art. 21

(Serraggio Singolo)

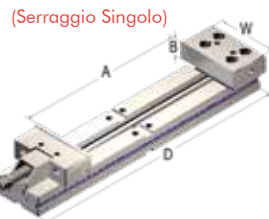

Tipo	2 - 25kN	3 - 30kN		4 - 30kN		
Apertura massima A	320	360	460	500	600	700
Larghezza ganasce W	125 mm	150 mm		175mm		
Altezza ganasce B	40	50		60		
Lunghezza base D	520	580	680	766	866	966
Cod.	2.21.23200	2.21.33600	2.21.34600	2.21.45000	2.21.46000	2.21.47000
kg	17	32	35	52	56	61
PREZZO LISTINO €	989	1.229	1.362	1.577	1.717	1.863
PREZZO OFFERTA €	750	950	1.100	1.300	1.400	1.500

LE PIÙ VENDUTE



Art.138 A squadra sovrapponibile

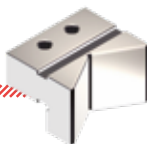

Art.150 Prismatica sovrapponibile

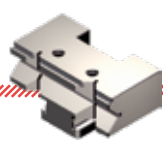

Art.217 Mobile Prismatica



Art.313 Piastra magnetiche parallele piane

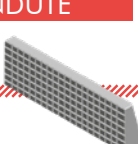

Art.230S Piastra ganascia quadrettata

*Risparmi fino al

20%

* Solo se acquistate con la morsa



Prolunghe Modulari

Elemento di prolunga (lato ganascia mobile) per morsa Art.1 - Art. 1A

In omaggio:



n. 4 staffe Art.298 + n.2 tasselli Art.297



Art.51



Tipo	2	3	4	5
Lunghezza base D	160	230	240	300
Cod.	1.80.23160	1.80.33230	1.80.43250	1.80.53300
kg	3,4	8,2	11,5	20
PREZZO LISTINO €	170	231	269	430

Art.1/1A + Art.51

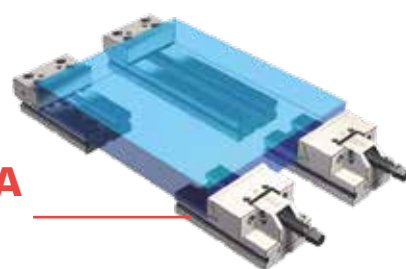



Kit Automazione

PER MORSE
ART.1 E ART.1A

Centraline con comando pneumatico
e cilindro a singolo effetto

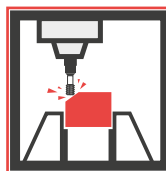

Risparmi fino al

11%

IDEALE PER CENTRI VERTICALI

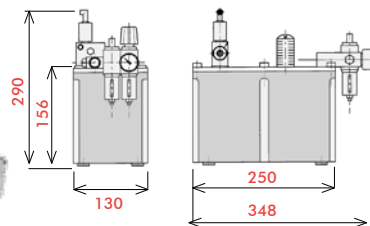
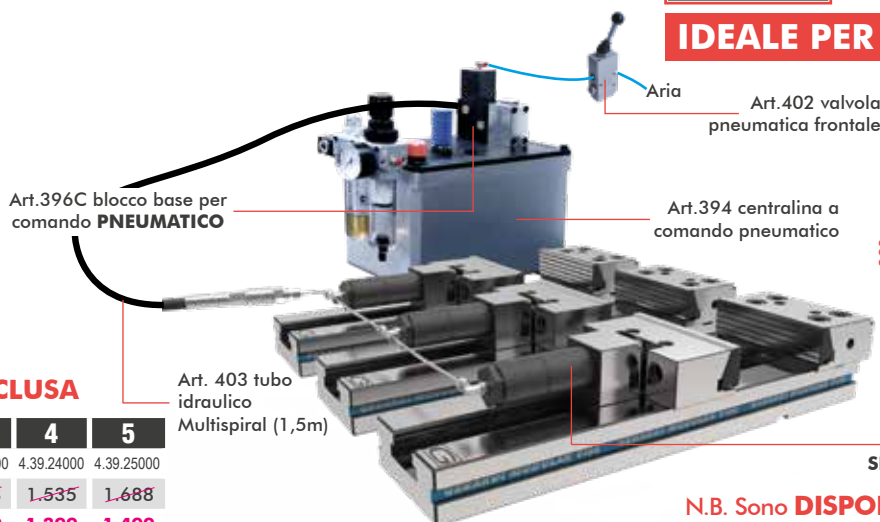

Art.392

N°1 SERRAGGIO
MORSA NON INCLUSA

Tipo	2	3	4	5
Cod.	4.39.22000	4.39.23000	4.39.24000	4.39.25000
PREZZO L. €	1.499	1.508	1.535	1.688
R. SPECIALE €	1.399	1.399	1.399	1.499

N.B. Sono **DISPONIBILI** anche centraline con elettrovalvole **PER CNC**

KIT di serraggio **SIMULTANEO** di più morse

* **Art.405H** (Non compreso) Tubo in acciaio zincato Ø6 (m1,0) Codice: 4.40.5H000

Art.392/2

(Art.271 - 394 - 402 - 403)

N°2 SERRAGGI
SIMULTANEI

Art.392 + N°1 Art.271

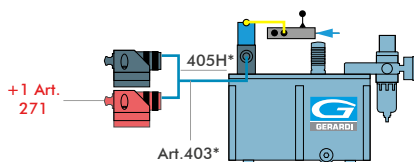

Tipo	2	3	4	5
Codice	4.39.22002	4.39.23002	4.39.24002	4.39.25002
PREZZO LISTINO €	1.804	1.823	1.877	2.182
PREZZO SPECIALE €	1.699	1.699	1.699	1.999

Art.392/3

N°3 SERRAGGI
SIMULTANEI

Art.392 + N°2 Art.271

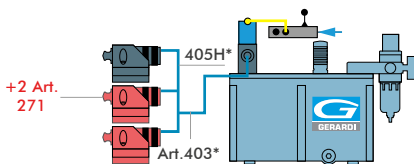

Tipo	2	3	4	5
Codice	4.39.22003	4.39.23003	4.39.24003	4.39.25003
PREZZO LISTINO €	2.109	2.136	2.216	2.675
PREZZO SPECIALE €	1.999	1.999	1.999	2.399

Art.392/4

N°4 SERRAGGI
SIMULTANEI

Art.392 + N°3 Art.271

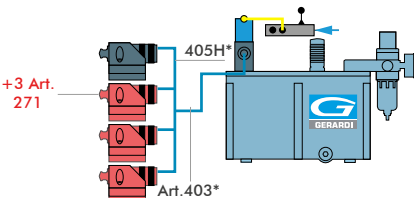

Tipo	2	3	4	5
Codice	4.39.22004	4.39.23004	4.39.24004	4.39.25004
PREZZO LISTINO €	2.416	2.450	2.559	3.170
PREZZO SPECIALE €	2.299	2.299	2.299	2.899

KIT di serraggio **INDIPENDENTE** di più morse

** **Art.403** (compreso) Tubo idraulico Multispiral 760bar completo di attacco rapido Art. 270A (m 1,5) Codice: 4.40.30000

Art.392A/2

(Art.271 - 394 - 402 - 403)

N°2 SERRAGGI
INDIPENDENTI

Art.392 + N°1 Art.407B

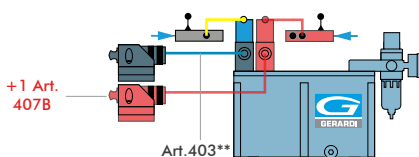

Tipo	2	3	4	5
Codice	4.39.2A202	4.39.2A302	4.39.2A402	4.39.2A502
PREZZO LISTINO €	2.452	2.469	2.531	2.915
PREZZO SPECIALE €	2.299	2.299	2.299	2.699

Art.392A/3

N°3 SERRAGGI
INDIPENDENTI

Art.392 + N°2 Art.407B

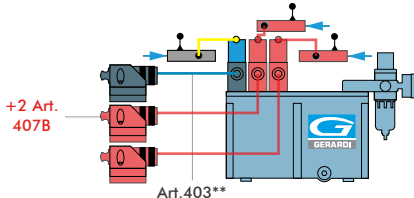

Tipo	2	3	4	5
Codice	4.39.2A203	4.39.2A303	4.39.2A403	4.39.2A503
PREZZO LISTINO €	2.854	2.880	2.959	3.401
PREZZO SPECIALE €	2.699	2.699	2.699	3.099

Art.392A/4

N°4 SERRAGGI
INDIPENDENTI

Art.392 + N°3 Art.407B

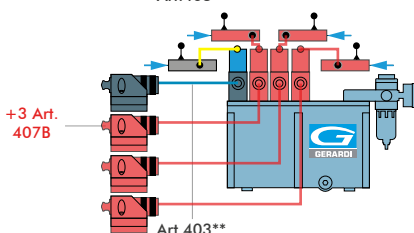

Tipo	2	3	4	5
Codice	4.39.2A204	4.39.2A304	4.39.2A404	4.39.2A504
PREZZO LISTINO €	3.534	3.568	3.671	4.260
PREZZO SPECIALE €	3.399	3.399	3.399	3.999

SCADENZA
31 LUGLIO 2020

Serraggio controllato e costante



FMS

Morse modulari di precisione

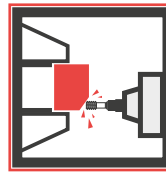
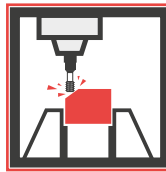

Risparmi fino al

20%

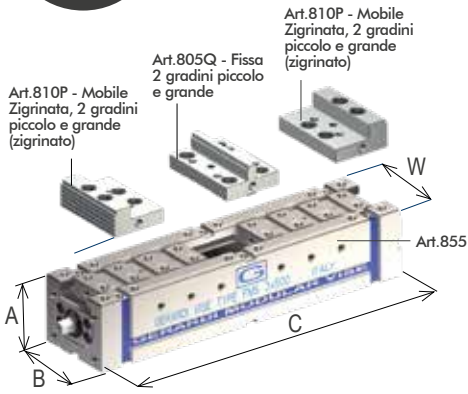

Art.864 Morsa doppia singola autocentrante con ganasce a doppio gradino zigrinate. Disponibile A RICHIESTA con ganasce lisce (8100)

Dot. standard: 1 Chiave a pipa, 2 tasselli di posizionamento, 1 piastrina di collegamento slitte morsa Art.801S e 2 arresti laterali +

In omaggio: n. 4 staffe Art. 298

Tipo W	2 (94mm) - 25kN			3 (124mm) - 30kN		4 (144mm) - 30kN
Altezza base A	90	90	90	100	100	120
Larghezza base B	95	95	95	125	125	145
Lunghezza base C	400	500	600	500	600	600
Cod.	5.86.42400	5.86.42500	5.86.42600	5.86.43500	5.86.43600	5.86.44600
PREZZO LISTINO € Morsa Completa Art.864	1.810	2.288	2.395	2.216	2.801	2.805
PREZZO OFFERTA € Morsa Completa Art.864	1.649	2.049	2.199	2.099	2.549	2.599

Con l'acquisto della morsa Art.864 a scelta una ganascia con Risparmio del 20%

- Art.8100** Ganascia mobile con gradino piccolo e grande
- Art.805F** Ganascia fissa con doppio gradino 3x5 liscia
- Art.810X** Ganascia mobile oscillante con gradino piccolo e grande

Cod.	5.81.00200	5.81.00300	5.81.00400
LISTINO €	190	207	257
OFFERTA €	152	166	206

Cod.	5.80.5F200	5.80.5F300	5.80.5F400
LISTINO €	186	206	256
OFFERTA €	149	165	205

Cod.	5.81.0X200	5.81.0X300	5.81.0X400
LISTINO €	287	325	364
OFFERTA €	230	260	291

- Art.810P + Art.805G**
- Art.805B** Ganascia fissa dolce
- Art.805G** Ganascia fissa con doppio gradino 3x5 zigrinata
- Art.805I** Ganascia fissa con doppio prisma verticale

Cod.	5.80.5B200	5.80.5B300	5.80.5B400
LISTINO €	126	142	195
OFFERTA €	101	114	156

Cod.	5.80.5G200	5.80.5G300	5.80.5G400
LISTINO €	186	206	256
OFFERTA €	149	165	205

Cod.	5.80.5I200	5.80.5I300	5.80.5I400
LISTINO €	186	206	256
OFFERTA €	149	165	205



Multiflex

Per serraggi multipli da 1 fino a 19 pezzi anche di diverse dimensioni

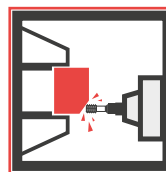
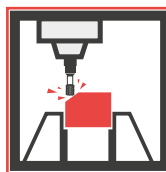

Risparmi fino al

33%

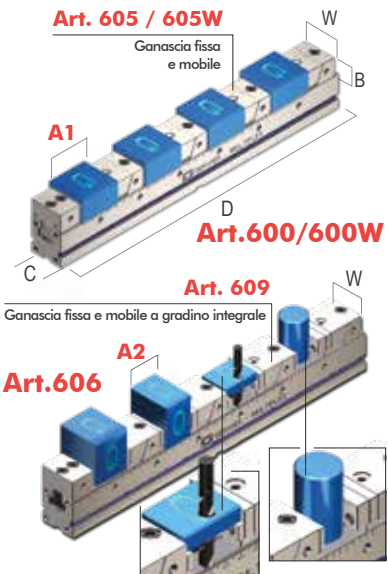

Ogni morsa è predisposta per il serraggio di 4 pezzi
Dot. Std : Chiave a "T", 2 tasselli di posizionamento e 4 arresti laterali +

In omaggio n.6 staffe Art. 298

Tipo	Art.600 / Art.600W							Art.606				
	mm	B	C ⁺⁰ _{-0.02}	D	W	A1mm	Cod.	PREZZO LISTINO	PREZZO OFFERTA	A2mm	Cod.	PREZZO LISTINO
1 20kN	32/25	50	300	49	4x8	6.60.01300	1.038	699	3x19	6.60.61300	1.572	1.150
	32/25	50	400	49	4x33	6.60.01400	1.128	799	4x23	6.60.61400	1.638	1.250
	32/25	50	500	49	4x58	6.60.01500	1.229	899	4x48	6.60.61500	1.738	1.350
	32/25	50	600	49	4x83	6.60.01600	1.340	999	4x73	6.60.61600	1.849	1.450
	32/25	50	700	49	4x108	6.60.01700	1.499	1.099	4x97	6.60.61700	2.009	1.550
2 30kN	40	75	400	74	4x12	6.60.02400	1.351	1.019	3x28	6.60.62400	1.957	1.450
	40	75	500	74	4x37	6.60.02500	1.451	1.149	4x24	6.60.62500	2.059	1.550
	40	75	600	74	4x62	6.60.02600	1.563	1.249	4x49	6.60.62600	2.173	1.650
	40	75	700	74	4x87	6.60.02700	1.674	1.349	4x74	6.60.62700	2.285	1.750
	40	75	800	74	4x112	6.60.02800	1.825	1.449	4x99	6.60.62800	2.446	1.850
NEW 3 40kN	40	75	900	74	4x137	6.60.02900	1.987	1.649	4x124	6.60.62900	2.608	1.950
	60	100	700	99	4x59	6.60.03700	1.937	1.549	4x44	6.60.63700	2.640	2.050
	60	100	800	99	4x84	6.60.03800	2.097	1.649	4x69	6.60.63800	2.801	2.150
	60	100	900	99	4x109	6.60.03900	2.260	1.849	4x94	6.60.63900	2.963	2.350
	60	100	1000	99	4x134	6.60.03100	2.477	2.049	4x119	6.60.63100	3.180	2.550

OFFERTA PIASTRE PARALLELE MAGNETICHE E RIPORTATE:

Art.616
Coppia di piastre parallele magnetiche piane per Art. 600

Risparmi **40%**

* Solo se acquistate con la morsa

ESEMPIO:
Art.600 2x600 con 4 coppie di piastre parallele magnetiche

PREZZO LISTINO: €1.249 + €127 anziché €212

Art.610E
Piastra parallela riportata per Art.606

Risparmi **20%**

* Solo se acquistate con la morsa



Cubi Portapezzi

Fusioni in ghisa monoblocco sgrassata con doppio trattamento di distensione

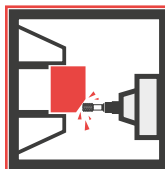

Risparmi fino al

34%

IDEALE PER CENTRI ORIZZONTALI

5th FACCIA LAVORABILE

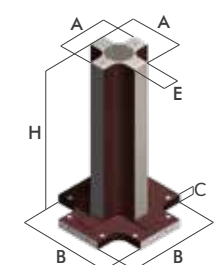
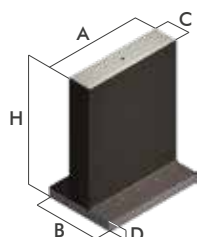
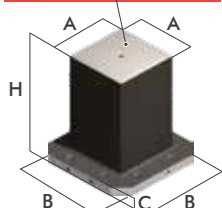

Art.53B

Cod.	A	B	C	H	kg	PREZZO LISTINO	PREZZO OFFERTA €
8.53.B00081	260	400	45	660	228	1.829	1.540
8.53.B00105	260	500	45	750	284	2.142	1.800
8.53.B00171	360	500	45	700	356	2.846	2.100
8.53.B00211	510	630	45	860	631	5.010	3.350

Solo per pallet a cave a "T"

Art.55B

Cod.	A	B	C	D	H	kg	PREZZO LISTINO	PREZZO OFFERTA €
8.55.B00052	400	400	160	50	660	244	2.004	1.600
8.55.B00053	500	500	160	50	700	331	2.677	2.100
8.55.B00172	630	630	210	55	850	545	4.429	3.340
8.55.B00190	800	450	160	65	800	604	4.965	3.840

Art.57B Con soli 3mm di SOVRAMETALLO !!!

Cod.	A	B	C	E	H	kg	PREZZO LISTINO	PREZZO OFFERTA €
8.57.B00100	203	500	40	80	750	157	1.316	1.250
8.57.B00110	273	500	40	80	850	235	1.783	1.600
8.57.B00120	233	500	40	110	850	218	1.685	1.500
8.57.B00140	303	630	40	150	950	327	2.341	2.050

New

Art.53B2 PLUS

Cod.	kg	PREZZO LISTINO	PREZZO OFFERTA €
8.53.B20081	204	2.221	1.900
8.53.B20105	254	2.601	2.200
8.53.B20171	326	3.456	2.800
8.53.B20211	593	6.084	4.100

A

Fusione in ghisa G30 monoblocco sgrassata con doppio trattamento di distensione. Pareti spessore 43-45 mm (Sovrametallo 10 mm)

B

Fusione sgrassata con base lavorata e raschiata per pallet a norme Europee o Giapponesi. Predispersione della base di appoggio di n. 4 fori Ø 20F7 e filetto M16 con interassi precisi, pronte per l'utilizzo dei ns. Zero Point, oppure per l'interfacciamento con altri pallet o piastre.

C

Cubo completamente finito con pareti spessore 38-40 mm circa. Tolleranza ± 0,02 mm

B2 PLUS

Sovrametallo 1mm su ogni faccia. Pronto da installare e da azzerare con assi macchina

New

Art.55B2 PLUS

Cod.	kg	PREZZO LISTINO	PREZZO OFFERTA €
8.55.B20052	206	2.434	2.000
8.55.B20053	303	3.251	2.600
8.55.B20172	520	5.378	4.100
8.55.B20190	782	6.029	4.700

New

Art.57B2 PLUS

Cod.	kg	PREZZO LISTINO	PREZZO OFFERTA €
8.57.B20100	155	1.504	1.350
8.57.B20110	241	2.126	1.850
8.57.B20120	216	2.800	1.700
8.57.B20140	325	2.731	2.300

E

Cubo a reticolo con fori calibrati e filetti integrali. Tolleranza ± 0,02 mm

F

Cubo a reticolo con bussole temperate 100 Cr6 e filetti riportati in acciaio inox. Tolleranza ± 0,02 mm

Cubi integrali con piastra base

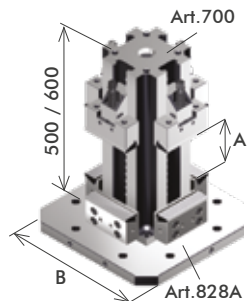

Art.700 + 828A (incluso)

Cubi-Morse modulari serie STD con piastra base personalizzata

Tipo 3 A 270 B 400 Cod. 3.70.02803 € 4.463 € 3.399	Tipo 3 A 270 B 500 Cod. 3.70.02803 € 4.976 € 3.899
---	---

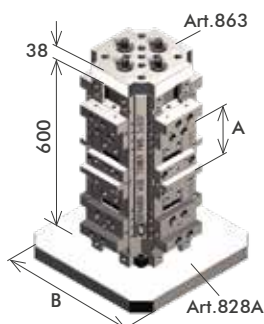

Art.863C + 828A (incluso)

Cubi-Morse modulari serie FMS con piastra base personalizzata

Tipo 3 A 2x262 B 400 Cod. 5.86.3C360 € 13.183 € 9.999	Tipo 3 A 2x262 B 500 Cod. 5.86.3C360 € 13.696 € 10.399
--	---

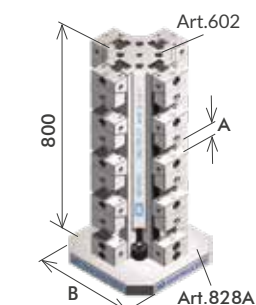

Art.602 + 828A (incluso)

Cubi-Morse modulari serie MULTIFLEX con piastra base personalizzata

Tipo 2 A 4x112 B 400 Cod. 6.60.22800 € 10.258 € 7.799	Tipo 2 A 4x112 B 500 Cod. 6.60.22800 € 10.771 € 8.199
--	--





FMS

Morse modulari di precisione
Per serraggi singoli, doppi e autocentranti

Made in Italy

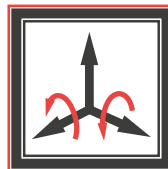

Prezzo di listino

IDEALE PER CENTRI A 5 ASSI

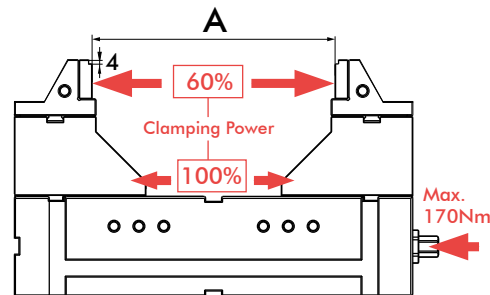
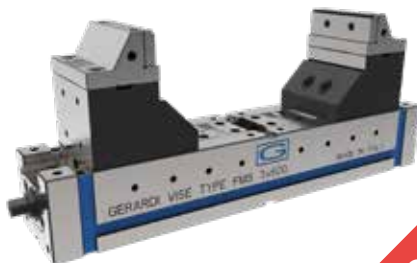
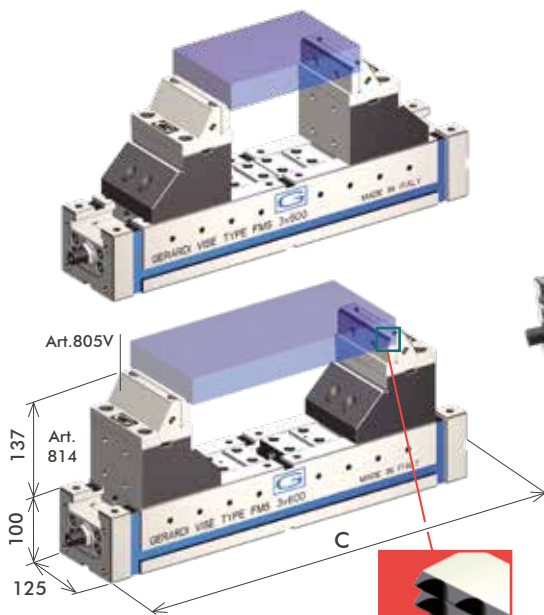

MORSA FMS con GANASCE ALTE

Possibilità di utilizzo di qualsiasi ganasce fissa FMS anziché del corpo ganasce 805V
Possibilità di due posizioni per ciascuna ganasce fissa e per base ganasce mobile Art.814

Dot. Std: 1 Chiave a pipa, 1 piastrina di collegamento
slitte morsa Art.801S, 2 tasselli di posizionamento e 1 arresto laterale

Omaggio: n. 4 staffe Art. 298

Tipo (W)	3 (124mm) - 30kN	
Apertura Massima A	344	444
Lunghezza base C	500	600
Cod.	5.86.83500	5.86.83600
PREZZO LISTINO €	2.236	2.802

Art.868

Morsa autocentrante (opzione doppia o singola)
con ganasce alte. Ideale per centri di lavoro a 5 assi

Art.247T GRIP



GripMatic

Idraulica o pneumatica
a doppio effetto

MORSA AUTOMATICA
AUTOCENTRANTE

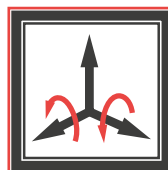

Prezzo di listino

IDEALE PER CENTRI A 5 ASSI

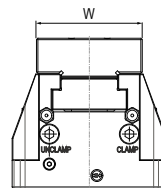
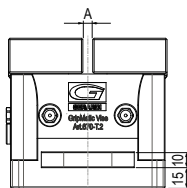
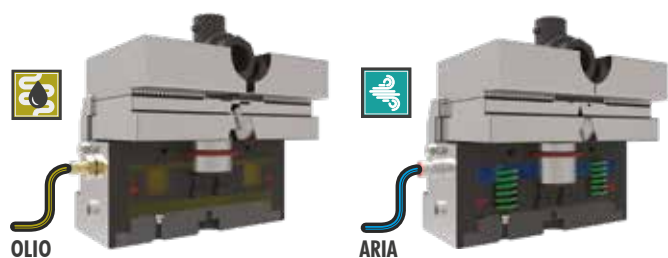

Standard equipment: - 4x Viti calibrate (Art.83) - Perno di centraggio (Art.670P)
- Adattatore per adduzione diretta aria / olio (Art.670IDL) - Valvola di non ritorno (Art.PN16)

Tipo	2	3	4
Larghezza ganasce W	74	99	124
Apertura massima A	6,4	8,5	12
Altezza morsa	105	135	165
Altezza base	80	105	130
Larghezza morsa	106	166	206
Interasse fori di centraggio e fissaggio	90	140	170
Pressione di esercizio		Max 10BAR	
Forza	5,1 kN	16 kN	22 kN
ART.670 Pneumatico - Cod.	7.67.OPN20	7.67.OPN30	7.67.OPN40
PREZZO LISTINO €	1.545	2.060	2.730
Pressione di esercizio		30 Bar	25 Bar
Forza	12,8kN	32kN	43kN
ART.670 Idraulico - Cod.	7.67.0ID20	7.67.0ID30	7.67.0ID40
PREZZO LISTINO €	1.545	2.060	2.730

Art.670

Morsa autocentrante idraulica o
pneumatica, ideale per centri a 5 assi



CompactGRIP

Morsa autocentrante con ganasce reversibili

Made in Italy

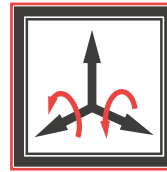

Risparmi fino al

20%

Art.650

Dotazione standard: 1 Chiave a pipa, 1 Perno calibrato o tirante Z.P.
2 tasselli di posizionamento e 2 tasselli per regolazione autocentrante +

In omaggio: Coppia inserti G11 + Arresto laterale Art. 370EM

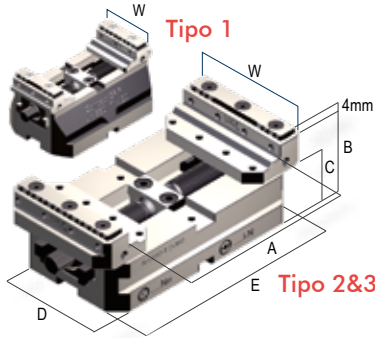

Tipo	1 - 12kN			2 - 22kN				3 - 32kN				
Larghezza ganasce W	50			88				123				
Apertura massima A	54	94	134	96	136	176	216	133	183	233	283	333
Altezza morsa B	65			65				89				
Altezza corpo C	45			38				57				
Larghezza base D	79,9			89,9				124,9				
Lunghezza base E	80	120	160	120	160	200	240	160	210	260	310	360
Kg	1,9	2,7	3,4	3,6	4,4	5,2	5,8	9,1	10,9	12,8	14,8	17
Cod.	7.65.01080	7.65.01120	7.65.01160	7.65.02120	7.65.02160	7.65.02200	7.65.02240	7.65.03160	7.65.03210	7.65.03260	7.65.03310	7.65.03360
PREZZO LISTINO €	670	773	876	824	927	1.030	1.133	1.339	1.545	1.751	2.060	2.266



Art.651H

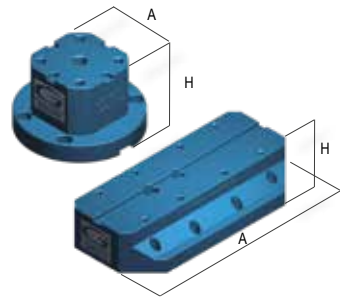

H	Tipo	1				2				3			
	Ingombro base A	Ø80	Ø120	Ø160	120	160	200	240	160	210	260	310	360
50	Cod.	7.65.1H1080/050	7.65.1H1120/050	7.65.1H1160/050	7.65.1H2120/050	7.65.1H2160/050	7.65.1H2200/050	7.65.1H2240/050	7.65.1H3160/050	7.65.1H3210/050	7.65.1H3260/050	7.65.1H3310/050	7.65.1H3360/050
	PREZZO LISTINO €	355	423	505	505	505	505	626	587	587	902	936	1.082
	PREZZO OFFERTA €	300	350	400	400	400	400	500	500	500	750	750	900
75	Cod.	7.65.1H1080/075	7.65.1H1120/075	7.65.1H1160/075	7.65.1H2120/075	7.65.1H2160/075	7.65.1H2200/075	7.65.1H2240/075	7.65.1H3160/075	7.65.1H3210/075	7.65.1H3260/075	7.65.1H3310/075	7.65.1H3360/075
	PREZZO LISTINO €	365	444	534	534	534	534	666	625	625	953	988	1.141
	PREZZO OFFERTA €	300	350	450	450	450	450	550	500	500	800	800	950
100	Cod.	7.65.1H1080/100	7.65.1H1120/100	7.65.1H1160/100	7.65.1H2120/100	7.65.1H2160/100	7.65.1H2200/100	7.65.1H2240/100	7.65.1H3160/100	7.65.1H3210/100	7.65.1H3260/100	7.65.1H3310/100	7.65.1H3360/100
	PREZZO LISTINO €	376	464	563	563	563	563	707	662	662	1.007	1.041	1.206
	PREZZO OFFERTA €	300	400	450	450	450	450	600	550	550	800	900	1.000



Multitasking

Morse autocentranti o eccentriche
Ideali per centri di lavoro a 5 assi

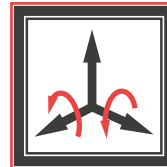

*Risparmi fino al

46%

* Solo se acquistate con la morsa

Dot. Standard :
1 arresto laterale
1 chiave a pipa, 1 coppia di tasselli di orientamento Art.297
1 perno di centraggio Art.640P +

IN OMAGGIO:
n.2 ganasce Art. 645T

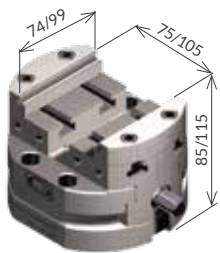

Morsa Art.640	Tipo 1 - 16 kN	Tipo 2 - 20 kN
Cod.	6.64.01000	6.64.02000
PREZZO LISTINO €	218 + 1.603	248 + 1.972
PREZZO OFFERTA €	999	1.199

IDEALE PER CENTRI A 5 ASSI



Rialzo Semplice per morsa Art.640

Rialzo Art.641H	Tipo 1	Tipo 2
Cod.	7.64.1H100AL/100	7.64.1H200AL/100
PREZZO LISTINO €	563	600
PREZZO OFFERTA €	379	399



Art.645B
Ganascia Dolce

Tipo	1	2
Cod.	6.64.5B100	6.64.5B200
LISTINO €	87	103
OFFERTA €	67	80



Art.645C
Ganascia Liscia

Tipo	1	2
Cod.	6.64.5C100	6.64.5C200
LISTINO €	87	103
OFFERTA €	67	80



Art.645D
Ganascia zigrinata

Tipo	1	2
Cod.	6.64.5D100	6.64.5D200
LISTINO €	87	103
OFFERTA €	67	80



Art.645E
Ganascia a gradino

Tipo	1	2
Cod.	6.64.5E100	6.64.5E200
LISTINO €	98	114
OFFERTA €	76	88



Art.645F
Ganascia prismatica

Tipo	1	2
Cod.	6.64.5F100	6.64.5F200
LISTINO €	109	124
OFFERTA €	84	96

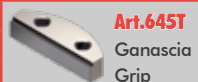

Art.645T
Ganascia Grip

Tipo	1	2
Cod.	6.64.5T100	6.64.5T200
LISTINO €	109	124
OFFERTA €	84	96

IN DOTAZIONE

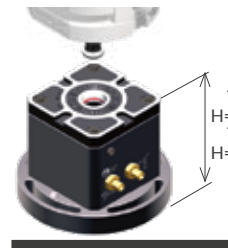

Rialzo con zero point per morsa Art.640 per cambio rapido

Dot Standard :
1 tirante Art.10S / 11S
1 tappo teflon con O-ring Art.9
1 perno di centraggio Art.640P,
1 spina di orientamento Art.79

Rialzo Art.63	Tipo 1	Tipo 2
Cod.	9.63.10000	9.63.2000
PREZZO LISTINO €	1.065	1.783
PREZZO OFFERTA €	899	1.399



Zero Point

Tempi di attrezzaggio ridotti del 90%

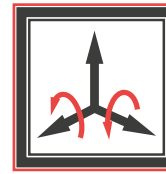
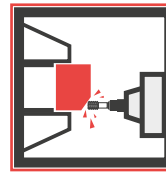
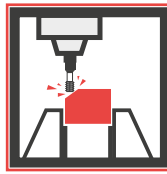

Risparmi fino al

31%

IDEALE PER CENTRI VERTICALI ORIZZONTALI e 5 ASSI

PNEUMATICO MULTIPLO
Ripetibilità entro 0,005 mm

Standard 10kN

Opzione 18kN
mediante molle
maggiorate



Dot. Standard:
1 firante Art.11A
1 tappo teflon
con O-Ring Art.9

PNEUMATICO SINGOLO
Ripetibilità entro 0,005 mm

Standard 10kN

Opzione 25kN
mediante molle
maggiorate

Art. 664

Ø90-Ø138-Ø168



Art. 665

Ø90-Ø138-Ø168



Art. 664S

Ø90-Ø120-Ø168



Art. 665S

Ø90-Ø120-Ø168

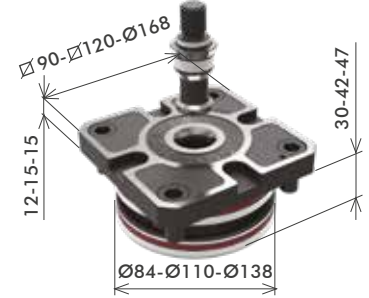

CON FLANGIA			
Tipo	1	2	3
Cod.	9.66.41000	9.66.42000	9.66.43000
kN	5,4	10	16
PREZZO L. €	631	820 €599	1.030

INCASSATO			
Tipo	1	2	3
Cod.	9.66.51000	9.66.52000	9.66.53000
kN	5,4	10	16
PREZZO L. €	526	711 €499	927

CON FLANGIA			
Tipo	1	2	3
Cod.	9.66.4S100	9.66.4S200	9.66.4S300
kN	5,4	10	16
PREZZO L. €	631	894 €699	1.030

INCASSATO			
Tipo	1	2	3
Cod.	9.66.5S100	9.66.5S200	9.66.5S300
kN	5,4	10	16
PREZZO L. €	526	788 €599	927

Forza di serraggio 5 ÷ 40 kN / Forza di arresto oltre a 60 kN / Sbloccaggio ad aria 6 ÷ 14 bar / Cono di posizionamento con compensazione assiale / Doppio centraggio per firante per massima rigidità / Pulizia ad aria / solo per ZERO POINT SINGOLI (versione S) 4 CHIAVETTE e FUNZIONE DOPPIOEFFETTO.

Kit Sovratavole interfacciate con Zero Point pneumatici

KIT #1 e #2 Posizionamento & fissaggio **INCLUSI**

KIT #3 e #4 Posizionamento **INCLUSO**, fissaggio (EXTRA)*

KIT#1
PER CENTRI VERTICALI

Art. 81P	PIASTRA BASE	200x400	200x500
PREZZO LISTINO €		1.959	2.038
PREZZO SPECIALE €		1.499	1.599

KIT#2
PER CENTRI ORIZZONTALI

Art. 80P	PIASTRA BASE	400x400	500x500	630x630
PREZZO L. €		3.911	4.260	4.828
R. SPECIALE €		2.899	3.099	3.599

KIT#3
PER CENTRI VERTICALI

Art. 81P	PIASTRA BASE	400x600	400x800
PREZZO LISTINO €		5.800	6.099
PREZZO SPECIALE €		4.299	4.599

KIT#4
PER CENTRI A 5 ASSI

Art. 82P	PIASTRA BASE TONDA	Ø425	Ø500	Ø630
PREZZO L. €		4.221	4.336	4.850
R. SPECIALE €		3.199	3.299	3.799

Piastre d'interfaccia per Zero Point e per tavola macchina

Art. 61i	LISCE	200x400	200x500
PREZZO LISTINO €		670	773
PREZZO SPECIALE €		499	599

Art. 61iE	A RETICOLO INTEGRALE		
LISTINO PREZZI €		788	1.010
PREZZO SPECIALE €		599	699

Art. 60i	LISCE	400x400	500x500	630x630
PREZZO L. €		965	1.179	1.391
R. SPECIALE €		699	899	999

Art. 60iE	A RETICOLO INTEGRALE			
PREZZO L. €		1.229	1.574	2.616
R. SPECIALE €		899	1.199	1.999

Art. 61i	LISCE	400x600	400x800
PREZZO LISTINO €		1.447	1.982
PREZZO SPECIALE €		1.099	1.499

Art. 61iE	A RETICOLO INTEGRALE		
LISTINO PREZZI €		1.694	2.513
PREZZO SPECIALE €		1.299	1.899

Art. 62i	LISCE	Ø425	Ø500	Ø630
PREZZO L. €		1.050	1.200	1.450
R. SPECIALE €		799	949	1.099

Art. 62iE	A RETICOLO INTEGRALE			
PREZZO L. €		1.241	1.575	2.100
R. SPECIALE €		949	1.199	1.599



BMT 45/55/65/75/85

L'eccellenza tecnologica !

Made in Italy

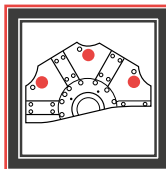

Risparmi fino al

32%

MOTORIZZATI PER TORNI CNC

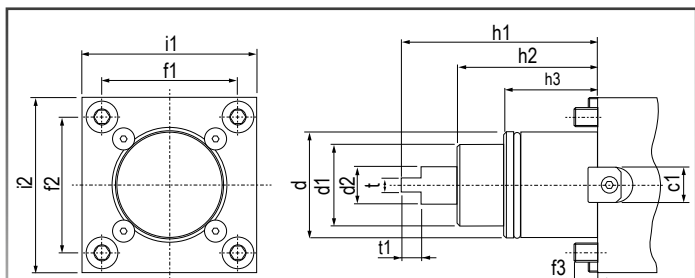

BMT	c1	d	d1	d2	f1	f2	f3	h1	h2	h3	i1	i2	t	t2
45	15	Ø45	35	14	58	58	10	84	60	40	75	75	6	8,5
55	15	Ø55	40	16	64	64	14	104	75	30	85	85	8	8,5
65	18	Ø65	45	18	70	73	15	112	83	32	94	94	10	14
75	25	Ø75	55	23	90	90	15	110	80	43	112	112	14	15
85	25	Ø85	65	33,5	100	100	18	140	100	43	125	125	16	20



COMPATIBILI CON TORNI
DOOSAN / HARDINGE /
SAMSUNG / HWACHEON /
HYUNDAI WIA /
VICTOR / HAAS



Assiali

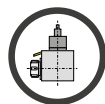
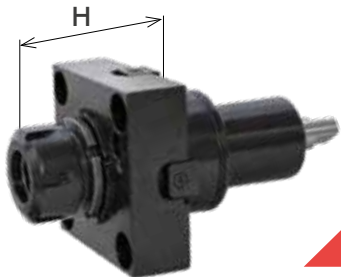

Radiali



BMT 65 Compatibili
anche con torni HAAS !!

BMT	Cod	ER	H	Nm	Rpm	PREZZO LISTINO €	PREZZO SPECIALE €
45	99.DS.A03	25	Max 57,2	35	8000	972	799
	99.DS.A04	25	Max 57,2	35	8000	1.110	899
55	99.DS.A01	25	Max 57,2	40	8000	1.020	799
	99.DS.A02	25	Max 57,2	40	8000	1.170	899
65	99.DS.A41	32	Max 72,5	70	6000	1.200	899
	99.DS.A42	32	Max 72,5	70	6000	1.380	999
75	99.DS.A34	40	Max 90,2	100	6000	1.410	1.199
	99.DS.A35	40	Max 90,2	100	6000	1.620	1.299

BMT	Cod	*	ER	H	Nm	Rpm	PREZZO LISTINO €	PREZZO SPECIALE €
45	99.DS.A07C	25	65	35	8000		1.716	1.399
	99.DS.A08C	25	65	35	8000		2.064	1.699
55	99.DS.A11C	25	70	40	8000		1.920	1.399
	99.DS.A12C	25	70	40	8000		2.268	1.699
65	99.DS.A51C	32	72	70	6000		2.016	1.499
	99.DS.A52C	32	72	70	6000		2.388	1.799
75	99.DS.A38C	40	60	100	6000		3.120	2.499
	99.DS.A39C	40	60	100	6000		3.744	2.999

* Disponibili sia con rotazione uguale sia contraria al mandrino macchina

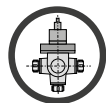

Orientabili



BMT	Cod	ER	H	Nm	Rpm	PREZZO LISTINO €	PREZZO SPECIALE €
45	99.DS.A16	20	65	15	8000	4.428	3.599
	99.DS.A17	20	65	15	8000	5.760	4.599
55	99.DS.A23	20	65	15	8000	4.428	3.599
	99.DS.A66	20	65	15	8000	5.760	4.599
65	99.DS.A64	25	75	25	6000	4.920	3.999
	99.DS.A65	25	75	25	6000	6.360	5.099
75	99.DS.A47	25	75	25	6000	4.920	3.999
	99.DS.A48	25	75	25	6000	6.360	5.099

KIT#1

New

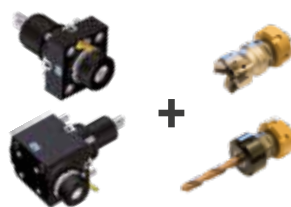

Acquistando
2 Motorizzati + 2 Cambi
Rapidi

RISPARMI

il 15% sui 2 cambi rapidi ordinati

il 10% se ordini 1 cambio rapido

KIT#4

New



Acquistando un
Kit di 3 Cambi Rapidi
(Ghiera Interna o Ghiera Esterna)

RISPARMI

il 15%

PREZZO LISTINO Cad. € 400

SCADENZA
31 LUGLIO 2020

Un' ampia gamma di Motorizzati con un imbattibile rapporto qualità-prezzo

11



Motorizzati regolabili

ORIENTATI MEGLIO!!!

Motorizzati orientabili $\pm 90^\circ$

Made in Italy

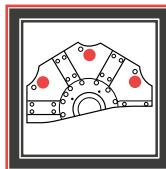

Risparmi fino al

32%

MOTORIZZATI PER TORNI CNC

Progettiamo e realizziamo porta utensili motorizzati ORIENTABILI che permettono fresature, forature e maschiature con diverse angolazioni ($\pm 90^\circ$)



PRECISIONE E AFFIDABILITÀ GARANTITE 2 ANNI !!

ASSISTENZA RAPIDA ED ECONOMICA ESEGUITA DAI NOSTRI SPECIALISTI !

■ Corpo

Trattamento protettivo anti-ossidante del corpo in acciaio integrale a sezione maggiorata per ridurre vibrazioni e aumentare la rigidità

■ Refrigerazione Interna

Tutti i Motorizzati possono essere forniti con refrigerante interno e pressione fino 100bar. Rotazione a secco possibile!

■ Coppia & Rpm

Coppia disponibile fino a 100Nm e velocità fino a 12.000 Rpm

■ Uscite

Pinze ER / WELDON / HSK / CAT / SK / BT / CAPTO o uscite portafresa

■ Ingranaggi Gleason

Coppia conica di ingranaggi spirodali Gleason con evolvente rettificato per garantire una maggior forza e ridurre rumore e riscaldamento

■ Cuscinetti

Cuscinetti a contatto obliquo + cuscinetti a rulli conici su lato mandrino per maggiore rigidità e durata nel tempo



Opzioni:



REFRIGERAZIONE INTERNA



ALTA VELOCITÀ
Fino a 12.000 Rpm



PINZE COMPENSATE



CAMBI RAPIDI

Miyano

Ø45: ABX 51/64 TH2/TH3 - BNE 34/42 - BNJ 42/51

Ø54: ABX 51/64 THY - ABX 51/64 SYY

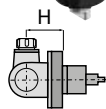

Ø	Cod	ER	H	Nm	Rpm	PREZZO LISTINO €	PREZZO SPECIALE €
45	99.MYA08	20	65	15	6000	4.059	3.299
	99.MYA13	20	65	15	6000	5.280	4.299
54	99.MYA19	20	75	15	6000	4.510	3.599
	99.MYA20	20	75	15	6000	5.867	4.699

Senso di rotazione uguale al mandrino

Nakamura

BMT44

WT100 -TW1

BMT55

SUPER NTJ-NTJX / NTM 3 / TMC 18 / TW10 / SC150-250 / WT150-250 / WTW 150 / WTS 150 / WT100

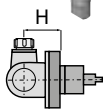

BMT	Cod	ER	H	Rpm	PREZZO LISTINO €	PREZZO SPECIALE €
44	99.NK.A59	16	68,5	6.000	4.059	3.299
	99.NK.A69	16	68,5	6.000	5.867	4.699
55	99.NK.A22	20	71	6000	4.059	3.299
	99.NK.A32	20	71	6000	5.280	4.199
65	99.NK.A82	25	80	6000	4.059	3.299

Senso di rotazione uguale al mandrino

Tsugami

BMT65:

M06D / M06SD / M06SY / M08D / M08SD / M08SY

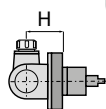

Cod	ER	H	Nm	Rpm	PREZZO LISTINO €	PREZZO SPECIALE €
99.TS.A24	20	65	15	8000	5.012	3.999
99.TS.A25	20	65	40	8000	6.478	5.199

Senso di rotazione uguale al mandrino

BMT

45 - 55 - 65 - 75

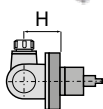

BMT	Cod	ER	H	Nm	Rpm	PREZZO LISTINO €	PREZZO SPECIALE €
45	99.DS.A16	20	65	15	8000	4.428	3.599
	99.DS.A17	20	65	15	8000	5.760	4.599
55	99.DS.A23	20	65	15	8000	4.428	3.599
	99.DS.A66	20	65	15	8000	5.760	4.599
65	99.DS.A64	25	75	25	6000	4.920	3.999
	99.DS.A65	25	75	25	6000	6.360	5.099
75	99.DS.A47	25	75	25	6000	4.920	3.999
	99.DS.A48	25	75	25	6000	6.360	5.099



Motorizzati regolabili

ORIENTATI MEGLIO!!!

Motorizzati orientabili ±90°

Made in Italy

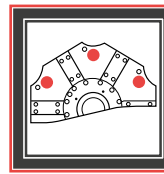

Risparmi fino al

32%

MOTORIZZATI PER TORNI CNC

Vdi

DIN69880

DIN5480

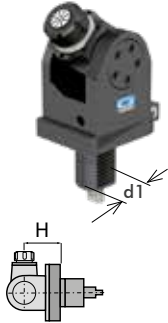

d1	Cod	ER	H	Nm	Rpm	PREZZO LISTINO €	PREZZO SPECIALE €
30	99.ST8087	20	64	15	6000	4.176	3.399
	99.ST8088	20	97	15	6000	4.176	3.399
	99.ST8091	20	64	15	6000	4.752	3.799
	99.ST8092	20	97	15	6000	4.752	3.799
40	99.ST8089	25	81	25	4000	4.752	3.799
	99.ST8093	25	81	25	4000	5.472	4.399
50	99.ST8090	40	123	50	4000	6.478	5.199

Senso di rotazione contrario al mandrino

Vdi

DIN69880

DIN5482

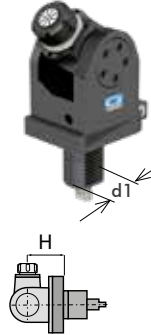

d1	Cod	ER	H	Nm	Rpm	PREZZO LISTINO €	PREZZO SPECIALE €
30	99.ST8248	20	64	15	6000	4.176	3.399
	99.ST8249	20	97	15	6000	4.176	3.399
	99.ST8254	20	97	15	6000	4.752	3.799
	99.ST8250	25	81	25	5000	4.752	3.799
40	99.ST8255	25	81	25	5000	5.472	4.399
	99.ST8251	25	100	25	4000	5.012	3.999

Senso di rotazione contrario al mandrino

Vdi

DIN69880

BARUFFALDI



d1	Cod	ER	H	Nm	Rpm	PREZZO LISTINO €	PREZZO SPECIALE €
30	99.BE0051	20	64	15	6000	4.176	3.399
	99.BE0052	20	97	15	6000	4.176	3.399
	99.BE0054	20	64	15	6000	4.752	3.799
	99.BE0055	20	97	15	6000	4.752	3.799
40	99.BE0053	25	81	25	5000	4.752	3.799
	99.BE0056	25	81	25	5000	5.472	4.399

Senso di rotazione contrario al mandrino

Vdi

DIN69880

DIN1809

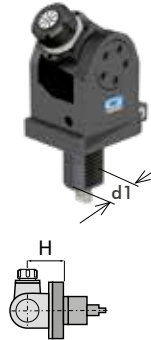

d1	Cod	ER	H	Nm	Rpm	PREZZO LISTINO €	PREZZO SPECIALE €
30	99.DR0940	20	64	15	6000	4.176	3.399
	99.DR0941	20	97	15	6000	4.176	3.399
	99.DR0943	20	64	15	6000	4.752	3.799
	99.DR0944	20	97	15	6000	4.752	3.799
40	99.DR0942	25	81	25	5000	4.752	3.799
	99.DR0945	25	81	25	5000	5.472	4.399

Senso di rotazione contrario al mandrino

Biglia

BMT 40 - 55

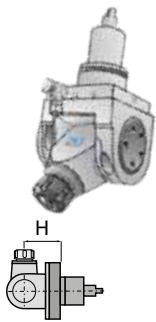

BMT	Cod	ER	H	Rpm	PREZZO LISTINO €	PREZZO SPECIALE €
40	99.BG.B55	11	91,5	6.000	4.666	4.200
	99.BG.B56	16	105	6.000	4.822	4.350
55	99.BG.B10	20	140	4000	3.400	3.300
	99.BG.B11	16	111	4000	3.660	3.550

Senso di rotazione uguale al mandrino

Dmg Mori

NLX - NZX - NZ - SL - ZL - DL

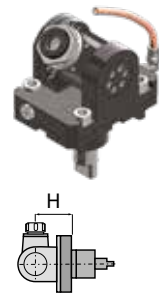

	Cod	ER	H	Nm	Rpm	PREZZO LISTINO €	PREZZO SPECIALE €
NLX	99.MS.A86	25	78	25	10.000	4.920	3.999
	99.MS.A87	25	78	25	10.000	6.360	5.099
NZ	99.MS.A118	20	50	17	12.000	4.920	3.399
	99.MS.A119	20	50	17	12.000	6.360	5.099
SL	99.MS.A55	20	66	25	6.000	4.510	3.699
ZL	99.MS.A56	20	66	25	6.000	5.830	4.699
DL							

Senso di rotazione uguale al mandrino

Haas

VDI 40



Presa di moto intercambiabile per le varie tipologie di torrette Haas

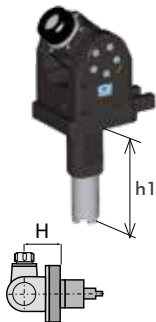

Cod	ER	H	h1	Nm	Rpm	PREZZO LISTINO €	PREZZO SPECIALE €
99.HA.00U1	25	81	69,3	25	6000	4.752	3.799
99.HA.00U1B	25	83	69,3	25	6000	5.472	4.399
99.HA.00U2	25	81	69,3	25	5000	4.752	3.799
99.HA.00U2B	25	81	69,3	25	5000	5.472	4.399
99.HA.00U3	25	81	69,3	25	6000	4.752	3.799
99.HA.00U3B	25	81	69,3	25	6000	5.472	4.399

Senso di rotazione uguale al mandrino

Mazak

QTN1 - QTN2 - QTN3 - QTS



	Cod	ER	H	Nm	Rpm	PREZZO LISTINO €	PREZZO SPECIALE €
QTN1	99.MZ.A56	20	85	63	6000	3.600	3.399
	99.MZ.A74	25	85	80	6000	4.000	3.699
QTN2	99.MZ.A64	25	85	80	6000	4.800	4.399
QTN3	99.MZ.A80	32	85	100	4000	6.000	4.999
	99.MZ.A14	25	80	30	6000	5.470	4.899
QTS	99.MZ.A15	25	80	30	6000	6.480	5.699

Senso di rotazione uguale al mandrino

SCADENZA 31 LUGLIO 2020

Un' ampia gamma di Motorizzati con un imbattibile rapporto qualità-prezzo

13



Motorizzati

L'eccellenza tecnologica!

Made in Italy

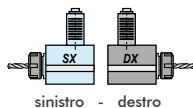

sinistro - destro

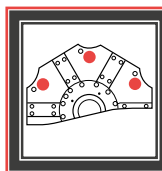

Risparmi fino al

32%



PRECISIONE E AFFIDABILITÀ GARANTITE 2 ANNI !!

ASSISTENZA RAPIDA ED ECONOMICA ESEGUITA DAI NOSTRI SPECIALISTI !

MOTORIZZATI PER TORNI CNC

Vdi

DIN69880

DIN5480

* In caso di ordine specificare sempre se sinistro o destro

d1	Cod	ER	H	Nm	Rpm	PREZZO LISTINO €	PREZZO SPECIALE €
30	99.ST8003	25	66	32	6000	864	699
	99.ST8011	25	66	32	6000	1.116	899
40	99.ST8005	32	95	63	6000	1.080	849
	99.ST8013	32	95	63	6000	1.412	1.099

Senso di rotazione uguale al mandrino

30	99.ST8030	25	55	32	6000	1.814	1.399
	99.ST8038	25	55	32	6000	2.088	1.749
40	99.ST8033	32	100	63	6000	2.296	1.699
	99.ST8041	32	100	63	6000	2.636	1.999

Senso di rotazione contrario al mandrino

Vdi

DIN69880

DIN5482

* In caso di ordine specificare sempre se sinistro o destro

d1	Cod	ER	H	Nm	Rpm	PREZZO LISTINO €	PREZZO SPECIALE €
30	99.ST8201	25	94	32	6000	814	699
	99.ST8207	25	94	32	6000	1.094	899
40	99.ST8203	32	115	63	5000	980	799
	99.ST8208	32	115	63	5000	1.268	999

Senso di rotazione uguale al mandrino

30	99.ST8217	25	55	32	6000	1.634	1.299
	99.ST8223	25	55	32	6000	1.908	1.499
40	99.ST8220	32	100	63	5000	1.958	1.499
	99.ST8226	32	100	63	5000	2.290	1.799

Senso di rotazione contrario al mandrino

Vdi

DIN69880

BARUFFALDI

* In caso di ordine specificare sempre se sinistro o destro

d1	Cod	ER	H	Nm	Rpm	PREZZO LISTINO €	PREZZO SPECIALE €
30	99.BE0003	25	94	32	6000	842	699
	99.BE0010	25	94	32	6000	1.124	899
40	99.BE0005	32	117	63	5000	1.016	799
	99.BE0011	32	115	63	5000	1.310	1.099

Senso di rotazione uguale al mandrino

30	99.BE0021	25	55	32	6000	1.678	1.399
	99.BE0027	25	55	32	6000	1.966	1.599
40	99.BE0024	32	53	63	5000	2.016	1.599
	99.BE0030	32	53	63	5000	2.362	1.899

Senso di rotazione contrario al mandrino

Vdi

DIN69880

DIN1809

* In caso di ordine specificare sempre se sinistro o destro

d1	Cod	ER	H	Nm	Rpm	PREZZO LISTINO €	PREZZO SPECIALE €
30	99.DR0903	25	94	32	6000	814	699
	99.DR0910	25	94	32	6000	1.094	899
40	99.DR0905	32	115	63	5000	980	799
	99.DR0911	32	115	63	5000	1.268	999

Senso di rotazione uguale al mandrino

30	99.DR0919	25	55	32	6000	1.634	1.299
	99.DR0925	25	55	32	6000	1.908	1.499
40	99.DR0922	32	100	63	5000	1.958	1.499
	99.DR0928	32	100	63	5000	2.290	1.799

Senso di rotazione contrario al mandrino

Biglia

BMT 55

BMT	Cod	ER	H	Rpm	PREZZO LISTINO €	PREZZO SPECIALE €
55	99.BG.B02.A	32	83,5	4.000	938	899
	99.BG.B02.D	32	83,5	4.000	1.358	1.299
55	99.BG.B05.A	32	70	4000	1.400	1.399
	99.BG.B05.B	32	70	4000	1.680	1.599

Senso di rotazione uguale al mandrino

Dmg Mori

NLX 1500 - 2000 - 2500 - 3000 16 Stazioni
NZX 12 Stazioni

Cod	ER	H	Nm	Rpm	PREZZO LISTINO €	PREZZO SPECIALE €
99.MS.G59	32	86,2÷89,9	60	10.000	1.176	899
99.MS.G60	32	86,2÷89,9	60	10.000	1.740	1.199
99.MS.G62	40	88,5÷92	60	10.000	1.176	899
99.MS.G63	40	88,3÷92	60	10.000	1.740	1.199
99.MS.A72	32	Max 90	60	10.000	2.520	1.849
99.MS.A73	32	Max 90	60	10.000	2.820	2.049
99.MS.A76	40	90	60	10.000	2.520	1.849
99.MS.A77	40	90	60	10.000	2.820	2.049

Entrambe direzioni di rotazione disponibili *

Biglia

BMT 40: B436

BMT	Cod	ER	H	Rpm	PREZZO LISTINO €	PREZZO SPECIALE €
40	99.BG.B40	20	57	6.000	1.322	1.299
	99.BG.B41	20	57	6.000	1.742	1.699
40	99.BG.B46	20	70	6.000	2.567	2.499
	99.BG.B47	20	45	6.000	2.645	2.599

Senso di rotazione uguale al mandrino

Dmg Mori

NZ 1500 - 2000 - 3100 - 3150 - 3200
16 Stazioni

Cod	ER	H	Nm	Rpm	PREZZO LISTINO €	PREZZO SPECIALE €
99.MS.A101	25	80,6÷84,3	50	12.000	1.176	949
99.MS.A102	25	80,6÷84,3	50	12.000	1.740	1.299
99.MS.A103	32	85,5÷89,2	50	12.000	1.176	949
99.MS.A104	32	85,5÷89,2	50	12.000	1.740	1.299
99.MS.A106	25	85	50	12.000	2.520	1.849
99.MS.A107	25	85	50	12.000	2.820	2.049
99.MS.A108	32	85	50	12.000	2.520	1.849
99.MS.A109	32	85	50	12.000	2.820	2.049



Motorizzati

L'eccellenza tecnologica !

Made in Italy

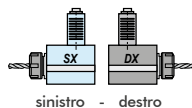

sinistro - destro

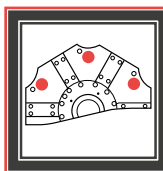

Risparmi fino al

32%



PRECISIONE E AFFIDABILITÀ GARANTITE 2 ANNI !!

ASSISTENZA RAPIDA ED ECONOMICA ESEGUITA DAI NOSTRI SPECIALISTI !

MOTORIZZATI PER TORNI CNC

Haas

VDI 40

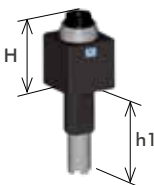

Cod	ER	H	h1	Nm	Rpm	PREZZO LISTINO €	PREZZO SPECIALE €
99.HA.590082	32	75	117,5	63	6000	890	699
99.HA.590082B	32	75	117,5	63	6000	1.110	899
99.HA.590083	32	75	104,8	63	6000	890	699
99.HA.590083B	32	75	104,8	63	6000	1.110	899
99.HA.596352	32	75	130,25	63	6000	890	699
99.HA.596352B	32	75	130,25	63	6000	1.110	899

Senso di rotazione uguale al mandrino



Presca di moto intercambiabile per le varie tipologie di torrette Haas



Cod	ER	H	h1	Nm	Rpm	PREZZO LISTINO €	PREZZO SPECIALE €
99.HA.590084	32	75	117,5	63	6000	1.670	1.299
99.HA.590084B	32	75	117,5	63	6000	2.110	1.699
99.HA.590085	32	75	104,8	63	6000	1.670	1.299
99.HA.590085B	32	75	104,8	63	6000	2.110	1.699
99.HA.596353	32	75	130,25	63	6000	1.670	1.299
99.HA.596353B	32	75	130,25	63	6000	2.110	1.699

Senso di rotazione uguale al mandrino

Mazak

QTN2

QUICK TURN NEXUS QTN 200/250
SUPER QUADREX TURN SQT 15/18 - 200/250



Cod	ER	H	Nm	Rpm	PREZZO LISTINO €	PREZZO SPECIALE €
99.MZ.A58	32	116,2÷120	80	6000	1.560	1.399
99.MZ.A59	32	116,2÷120	80	6000	2.400	1.799
99.MZ.A65	32	130	80	6000	1.667	1.499
99.MZ.A66	32	130	80	6000	2.200	1.799

Senso di rotazione contrario al mandrino

Mazak

SMART QTS1

QUICK TURN SMART QTS 100M / 200M
QT COMPACT 100M - 200M - 300M



Cod	ER	H	Nm	Rpm	PREZZO LISTINO €	PREZZO SPECIALE €
99.MZ.A03	32	Max 70	60	6000	1.555	1.299
99.MZ.A06	32	Max 70	60	6000	2.110	1.699
99.MZ.A09	32	80	60	6000	2.220	1.799
99.MZ.A10	32	80	60	6000	2.780	2.199

Senso di rotazione contrario al mandrino

Miyano

Ø45: ABX 51/64 TH2/TH3 - BNE 34/42 - BNJ 42/51
Ø54: ABX 51/64 THY - ABX 51/64 SYY

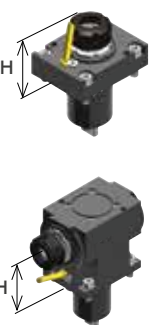

Ø	Cod	ER	H	Nm	Rpm	PREZZO LISTINO €	PREZZO SPECIALE €
45	99.MYA02	25	53,9÷57,6	35	6000	803	699
	99.MYA03	25	53,9÷57,6	35	6000	963	799
54	99.MYA09	32	75,7÷79,4	60	6000	935	799
	99.MYA10	32	75,7÷79,4	60	6000	1.073	899
45	99.MYA05	25	65	35	6000	1.419	1.199
	99.MYA06	25	65	35	6000	1.705	1.399
54	99.MYA11	32	75	60	6000	1.760	1.399
	99.MYA12	32	75	60	6000	2.079	1.699

Senso di rotazione contrario al mandrino

Nakamura

BMT44

WT100 -TW1

BMT55

SUPER NTJ-NTJX / NTM 3 / TMC 18 /
TW10 / SC150-250 / WT150-250 /
WTW 150 / WTS 150 / WT100



BMT	Cod	ER	H	Nm	Rpm	PREZZO LISTINO €	PREZZO SPECIALE €
44	99.NK.A40	25	Max 57,2	40	6000	891	699
	99.NK.A43	25	Max 57,2	40	6000	1.018	799
55	99.NK.A03	32	68,5÷72,2	63	6000	935	799
	99.NK.A04	32	68,5÷72,2	63	6000	1.441	1.199
44	99.NK.A50	25	60	40	6000	1.579	1.299
	99.NK.A53	25	60	40	6000	1.892	1.499
55	99.NK.A13	32	55	63	6000	1.760	1.399
	99.NK.A14	32	55	63	6000	2.373	1.899

Okuma

BMT60: SPACE TURN LB 200EX / LB 2500EX
/ LB3000EX / GENOS SERIES L300-MW / MULTUS
U3000 / U40007 / LU3000EX M / MY



BMT	Cod	ER	H	Nm	Rpm	PREZZO LISTINO €	PREZZO SPECIALE €
60	99.OK.A80	32	Max 79	60	6000	1.589	1.199
	99.OK.A81	32	Max 79	60	6000	2.017	1.499
60	99.OK.A82	32	70	60	6000	2.872	1.999
	99.OK.A83	32	70	60	6000	3.422	2.399

Senso di rotazione uguale al mandrino

Senso di rotazione contrario al mandrino

Tsugami

BMT65:

M06D / M06SD / M06SY /
M08D / M08SD / M08SY



Cod	ER	H	Nm	Rpm	PREZZO LISTINO €	PREZZO SPECIALE €
99.TS.A01	25	MAX 60	40	8000	1.467	1.199
99.TS.A02	25	MAX 60	40	8000	2.017	1.599
99.TS.A08	25	65	40	8000	2.383	1.899
99.TS.A09	25	65	40	8000	2.933	2.399

NEW



Teste Angolari

Alta velocità ed assoluta precisione !

Made in Italy

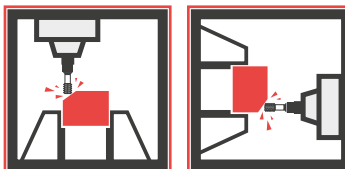

Risparmi fino al

12%

IDEALE PER CENTRI VERTICALI ORIZZONTALI

Classic XL Line

TESTE ANGOLARI SERIE XL

Ideali per centri di lavoro di grosse dimensioni. Studiate e progettate per grosse asportazioni.



Serie MTC (Cambio utensile manuale)

Tipo 5	Modello	Uscita	Rpm	Nm	Lunghezze opzionali	PREZZO LISTINO €
	G90-S40XL	ISO BT CAT 40	4.000	140	-	4.500
	G90-S40XLxx				H=400	6.900
					H=500	7.100
					H=600	7.300
GMU-S40	3.000	100	-	7.727		

Tipo 6	Modello	Uscita	Rpm	Nm	Lunghezze opzionali	PREZZO LISTINO €
	G90-S50	ISO BT CAT 50	3.000	400	-	10.480
	G90-S50Lxx				H=400	12.500
					H=500	13.000
					H=600	13.500
					H=700	14.000
GMU-S50	3.000	220	-	18.410		

Evolution Line

TESTE ANGOLARI

Coni intercambiabili per un utilizzo su più centri di lavoro



Serie ATC (Cambio utensile automatico)

Tipo 1 (Ø102)	Modello	Uscita	Rpm	Nm	PREZZO LISTINO €	Modello serie Lunga	PREZZO LISTINO €
	FS90-3	6023E	8.000	2	4.230		4.720
	FS90-4	600E	8.000	3,5	3.910		4.530
	F90-7	ER-11	10.000	6	3.245		3.690
	F90-10	ER-16	10.000	11	2.760		3.425
	F90-16S	ER-25	8.000	27	3.390		-
	FMU-10	ER-16	8.000	9	3.445		-
	FMU-16	ER-25	6.000	15	3.690		-

Tipo 2 (Ø128)	Modello	Uscita	Rpm	Nm	PREZZO LISTINO €	Modello serie Lunga	PREZZO LISTINO €
	F90-20	ER-32	3.500	85	3.800		4.860
					PREZZO SPECIALE 3.400		-

Tipo 3 (Ø157)	Modello	Uscita	Rpm	Nm	PREZZO LISTINO €	Modello serie Lunga	PREZZO LISTINO €
	F90-S40	ISO CAT BT 40	2.500	135	4.400		-
	FMU-20	ER-32	4.000	48	4.650		-

New

KIT Classic 1

1 Cambio rapido OMAGGIO acquistando 1 Testa G90-16

G90-16 + ER25

α € 3.424 anziché € 3.824

oppure

G90-16

Acquista 1 Testa G90-16

α € 2.999

New

KIT Evolution 1

1 Cambio rapido OMAGGIO acquistando 1 Testa F90-16S

F90-16S + ER25

α € 3.390 anziché € 3.790

oppure

F90-16S

Acquista 1 Testa F90-16S

α € 2.999

New

KIT Classic 2

1 Cambio rapido OMAGGIO acquistando 1 Testa G90-20

G90-20 + ER32

α € 3.620 anziché € 4.020

oppure

G90-20

Acquista 1 Testa G90-20

α € 3.200

New

KIT Evolution 2

1 Cambio rapido OMAGGIO acquistando 1 Testa F90-20

F90-20 + ER32

α € 3.800 anziché € 4.200

oppure

F90-20

Acquista 1 Testa F90-20

α € 3.400



GERARDI SPA

via Giovanni XXIII, 101
21015 LONATE POZZOLO (VA) Italia
Tel. +39.0331.303911 - Fax +39.0331.301534
gerardi@gerardispa.com - www.gerardi.it

Distributore:

100
anni
1906_2006

Airoldi & Belgeri
utensileria